

TADD-1 Assembly and Operation Manual

Six Channel RF Distribution Amplifier

Revised: 5 April 2014

©2005-14 Tucson Amateur Packet Radio Corporation

Introduction

NOTE: This is an update to the 2007 version of the manual that collects and hopefully corrects some additional information (including the change from the MAX477 to the AD8055 amplifier chip), and also provides some new performance information.

The TADD-1 is a six channel RF distribution amplifier. Its primary purpose is to allow one frequency source (typically a frequency standard) to drive several loads (typically the "external reference" input of frequency counters or other test equipment) with high isolation. The input frequency can range from 500 kHz to 30 MHz.

While the signal from a frequency standard is normally in the range of 0 to +13 dBm, an adjustable gain control allows the TADD-1 to be used with a wide range of input signal levels. The maximum output signal is approximately +12.7 dBm into 50 ohms (2.75 volts peak-to-peak, or 0.97 volt RMS). Maximum output voltage into a high impedance load is slightly higher. A jumper allows the input signal to be terminated in 50 ohms, or to operate at high impedance (approximately 47 kohms).

Each RF input and output on the TADD-1 is transformer coupled to minimize the possibility of ground loops. In addition, the connectors are capacitively coupled to ground to further improve isolation (and allow operation with signals riding on DC bias).

The TADD-1 includes a fused and reverse-polarity protected 9 volt regulator. The supply voltage can range from 11.5 to 24 volts. Current drain will depend on the output loads, but is typically in the range of 60 to 150 milliamps.

See the "Performance" section for further details.

Circuit Description

The TADD-1 uses the ~~Maxim~~ MAX477 Analog Devices AD8055 amplifier (please read all “MAX477” references in this document as “AD8055”). The MAX477 DIP package version has been discontinued. The AD8055 is a drop-in replacement with nearly identical performance; in fact, limited testing has shown that it has a few dB lower phase noise than the MAX477 device.

The MAX477 is a video amplifier designed to drive coax lines, so it is well suited to this application. It has a maximum operating frequency of 300MHz, and this requires care in the circuit design and layout to avoid oscillation and spurious outputs.

The input signal enters via J1 and T1. C11 provides an RF ground reference while maintaining DC isolation. JP1 and JP2 are headers that, if installed, allow several TADD-1 boards to be stacked and share a common RF input. JP3 allows 51 ohm resistor R12 to terminate the input signal if desired.

~~The MAX477 output level is internally clamped to a maximum of 7 volts peak-to-peak (5 volts Pk-Pk when loaded by 50 ohms). Since IC1 has a minimum gain of 2, it's possible that a strong input signal could overdrive the amplifier and result in output clipping. R4 and R6 form a voltage divider that can be used to reduce the input signal level if necessary. The default values (R4=10k and R6=100k) result in minimal attenuation. Changing their ratio allows greater attenuation. For example, using 47k for both resistors will reduce the input voltage by half. Given that the amplifier has a gain of up to 13, it's best to err on the side of increased attenuation if your input signal level is robust.~~

The voltage divider described in the deleted text above provided excess attenuation, and limited the TADD-1 to less than unity gain. In current units, R4 has been changed to 1 kohm and R6 has been eliminated. In addition, R1 and R8 have been changed from 15 kohms to 47 kohms. These changes substantially increase the maximum gain. All TADD-1 units shipped after September 15, 2006 include these changed components, and all earlier units may be retrofitted by changing the values of R4, R1, and R8 as noted, and removing R6. No board changes are required.

The TADD-1 operates from a single 9 volt regulated power supply, so input signals to the MAX477 amplifiers must ride on a 4.5 volt DC bias. R1 and R8 provide that bias for the input of IC1, and C8 provides DC isolation.

Trimmer R13 adjusts the gain of IC1. The gain of a non-inverting op amp is equal to $1 + R_b/R_a$. In the TADD-1, R_a is R10 (220) plus R13 (0 to 2.5 kohm) and R_b is R11 (2.7 kohm). Therefore, the gain ranges from about 2 (when R13 is set to 2.5 kohm) to about 13 (when R13 is set to 0 ohms). Because our circuit uses a single supply voltage, R_b is referenced to 1/2 the supply voltage rather than ground. R14 and R15 provide that reference. The value of R14 will also have some effect on the gain, so relatively low values (560 ohms) are used for this voltage divider. As a result, the full gain of 13 can't be reached; using lower value resistors at R14 and R15 permit higher gain, at the expense of greater power consumption.

Wire jumpers J2, J4, and J5 allow an optional bandpass filter to be added to the circuit. Normally, only J2 is installed, which bypasses the filter. Installing J4 and J5, and leaving J2 empty, put the filter in-line. The filter is described later in this manual.

The output of IC1 drives IC2 through IC7. The RF coming out of IC1 rides on a DC bias equal to half the supply voltage, and that bias is used on the input to the following amplifiers. This avoids the need for additional biasing components on the inputs of IC2-7.

If you observe the board layout, you'll see that the traces connecting to the inputs of IC2-7 are laid out in a serpentine fashion. This equalizes the lead length driving each amplifier, minimizing any difference in signal phase at the outputs. However, the inductance of those long leads may cause the high-bandwidth MAX477

to break into parasitic oscillations. R9 provides a low impedance load at the beginning of the "serpentine" and helps to stabilize IC1. It also provides a load for the bandpass filter if that is used. C12 prevents the DC bias from being grounded through the resistor. The 100 ohm resistors at the input to each of IC2 through IC7 decouple the amplifier from the long traces and are primarily responsible for stabilizing the system.

R9 was originally 51 ohms, but increasing that to 270 ohms allows somewhat higher output signal levels, and makes a significant difference in output if the optional bandpass filter is used. Increasing the value of this resistor does not seem to have an impact on stability, but in the event of parasitic oscillation, reverting to a lower value may help.

IC2-7 are configured as unity gain followers. Their outputs are DC isolated, fed through a "back termination" into an isolation transformer. As on the input, the connector is grounded through a capacitor to further reduce the possibility of ground loops,. The back termination is a 50 ohm series resistor designed both to match the coax cable impedance, and to ensure amplifier stability even when driving a capacitive load (such as a long coax cable). Because the back termination and the load impedance form a voltage divider, the output voltage into a 50 ohm load will be half the unloaded voltage. The adjustable gain of IC1 compensates for this loss (within reason).

The power supply uses a standard LM7809 regulator. JP5 and JP6 are provided for board-stacking purposes. F1 is a 0.5 amp pico-fuse. C39 and R27 form an input ripple filter. D1 provides reverse voltage protection; if the power leads are reversed, D1 will conduct and blow F1. To help stability and minimize noise, lots of bypass caps are used -- each MAX477 has a 0.1 and 0.001 cap at its supply input, and additional 1uF tantalum caps are spaced along the power bus.

OPTIONAL BANDPASS FILTER

NOTE: We do **not** recommend using the filter unless it is required by the application. Any tuned circuit will produce phase shifts that vary with temperature, and this creates an additional source of instability.

Also note that the earlier version of this document had some erroneous information about component values and toroid winding. That has been partially corrected in the assembly instructions, but the frequency response plot below is from the original filter testing and does not reflect the slightly changed values recommended now. And, the schematic has **not** been updated to show the changed values.

The optional bandpass filter (“BPF”) is laid out on the circuit board as a 2nd order series-input filter. The component values suggested in the schematic (and shown in the assembly instructions below) implement a Chebycheff filter with a center frequency of 10 MHz, though other designs can be used. Its rejection is greater than 30 dB at 5MHz (one-half the fundamental), and is 35 dB or more at 20 MHz (the second harmonic) and above. See the frequency response plot below for more performance details.

This plot is based on a 270 ohm value at R9, which terminates the filter. The value of this resistor has an impact on both the output level and the frequency response of the filter. Using a 50 ohm resistor will result in as much as 3 dB better stopband attenuation, but increases the insertion loss by almost 6 dB.

The assembly instructions include component values for center frequencies of both 5 MHz and 10 MHz.

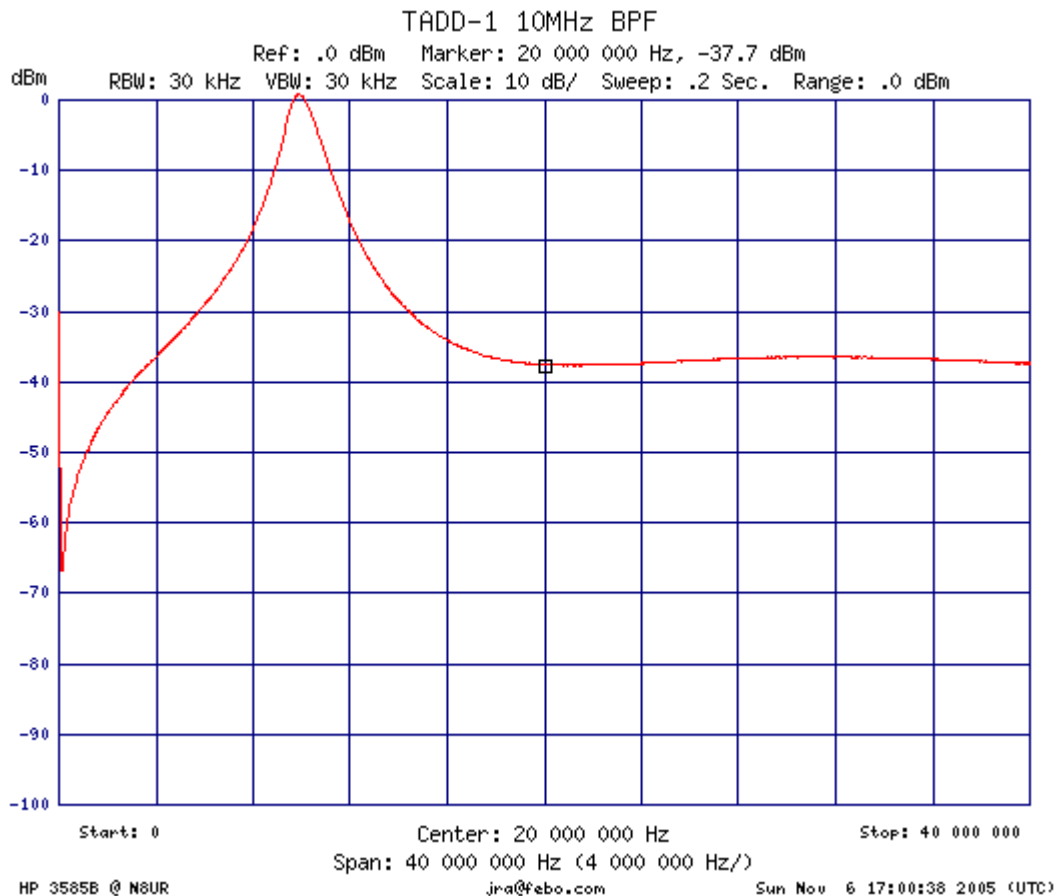

TYPICAL PERFORMANCE

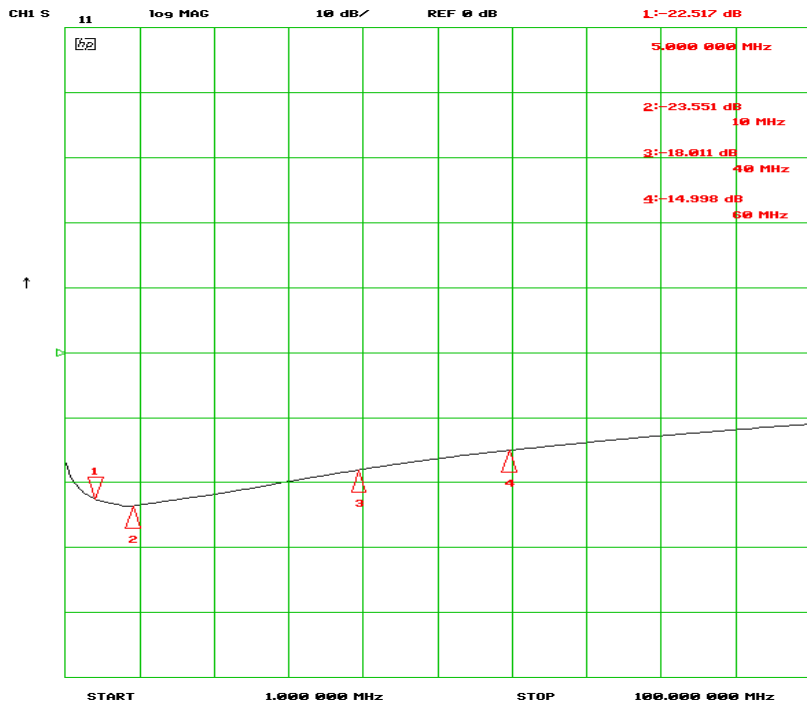
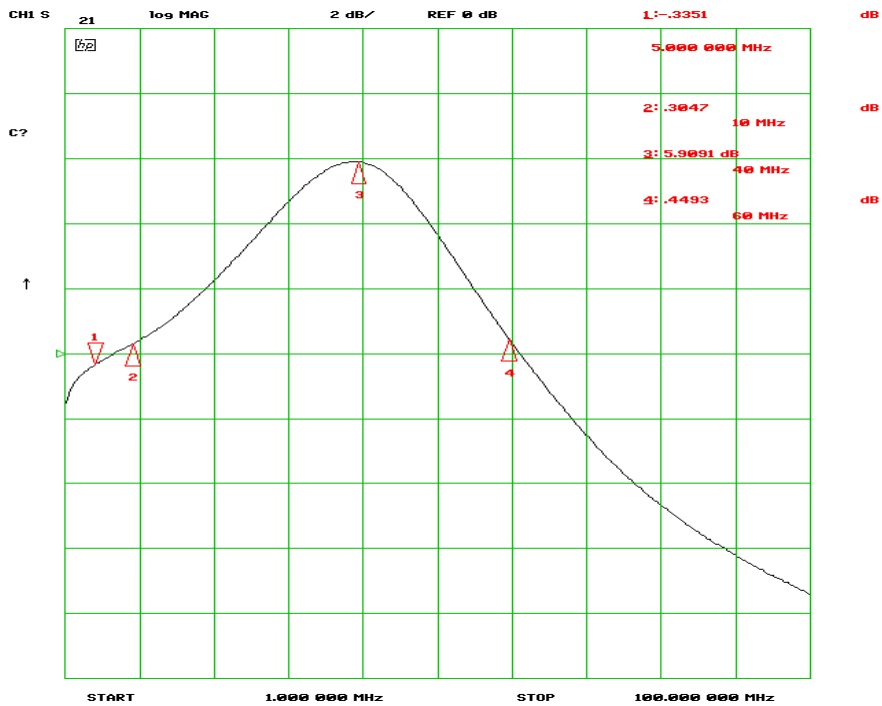

PHASE NOISE

This plot shows the residual phase noise of TADD-1 units. The blue trace is of a unit built with the MAX477 chips, and the magenta trace is a unit built with the AD8055.

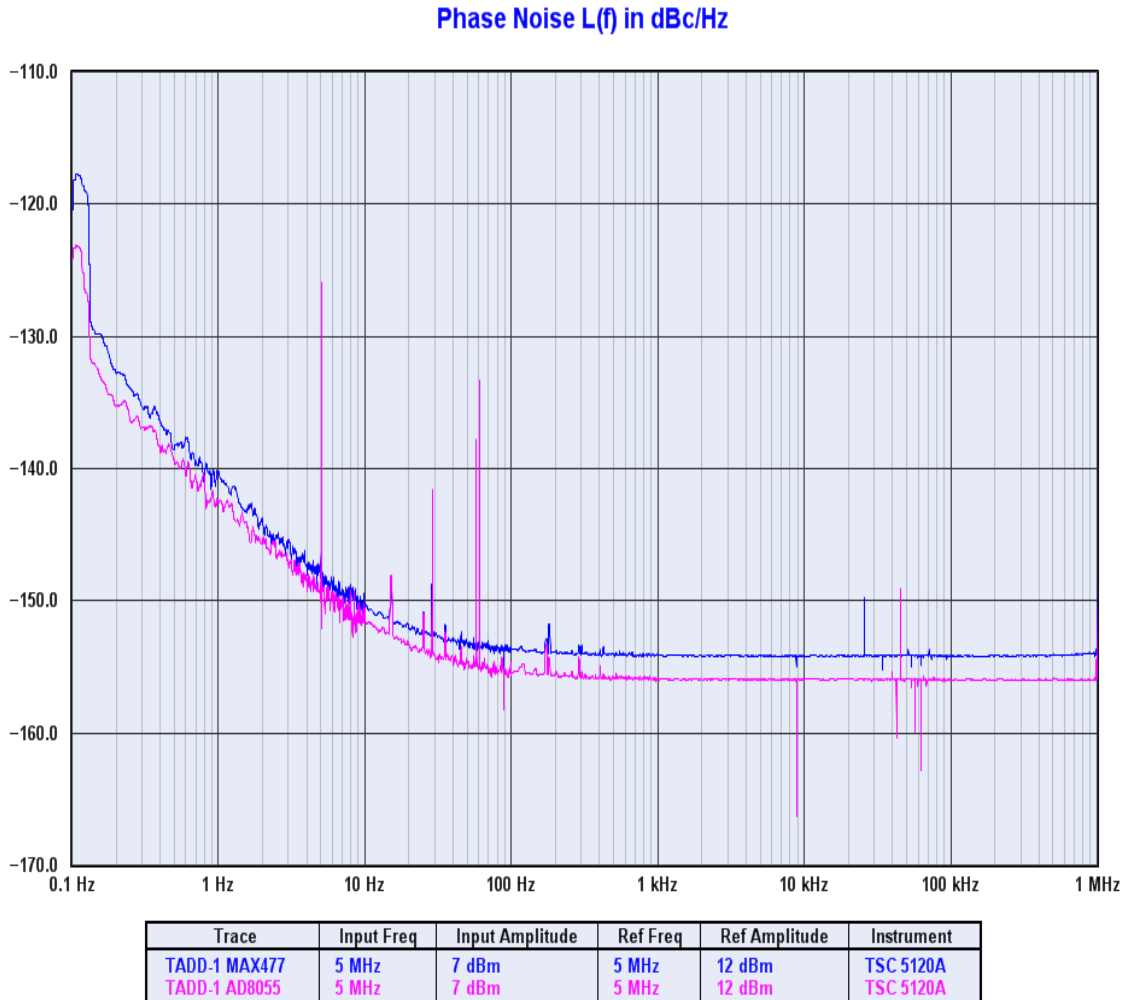

REVERSE ISOLATION

Isolation from an output channel to the input, and from output-to-output is typically greater than 80dB at 5 MHz and 10 MHz(which may be instrumentation-limited). Isolation decreases below 5 MHz.

PHASE DELAY ACROSS CHANNELS

This plot overlays the phase delay at 5 and 10 MHz of each of the six channels in a unit built without the bandpass filter. Channels 1 through 3 form a tight group with almost identical phase through the amplifier. Channels 4 through 6 show slightly higher delay (about 0.75 degrees at 5 MHz; much less at 10 MHz). I am not sure what causes this slight discrepancy; the good news is that the phase across all channels is consistent to well within 1 degree.

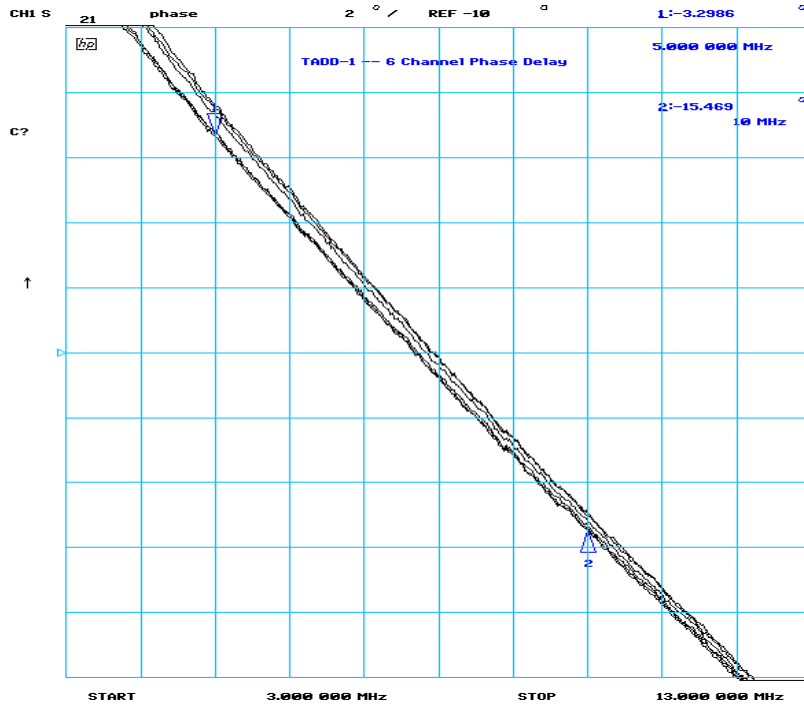

Typical Performance

Current Draw, 13.8V*

Condition (50 Ohm Loads)	Current
No Input, No Output	60ma
RF In, No Output	89ma
1 output	96ma
2 outputs	103ma
3 outputs	110ma
4 outputs	117ma
5 outputs	124ma
6 outputs	131ma

* Current will vary with input level and gain setting

Gain and Signal Levels (10MHz)

(NOTE: This data is based on the original design and has not been retested after circuit changes.)

Maximum input for no clipping at maximum gain: +3.5dBm terminated in 50 ohms.
Gain range with +3.5dBm input: -0.8 to +7.7 dB (output terminated in 50 ohms)

Maximum output level into 50 ohms: +12.7dBm

Maximum output level into high impedance: 5.12V peak-peak

Harmonics*

	Source (+6.7dBm)	Minimum Gain	Maximum Gain
Second Harmonic	-46	-45	-47
Third Harmonic	-54	-47	-46
Fourth Harmonic	-61	-55	-55

* This table is suspect because the gradually increasing gain curve of the TADD-1 through 40MHz will amplify the source harmonics more than the fundamental.

Preparation

The TADD-1 kit includes the printed circuit board, a bag with seven BNC connectors, and several manila envelopes containing small components. Parts that are used in quantity are in separate envelopes, labeled with the component each contains. One or more envelopes labeled "Misc." contain parts that are used in small quantities. Integrated circuits and transformers may be stuck to anti-static foam, or be placed in plastic tubes. The 7809 voltage regulator will be in one of the "Misc." envelopes. Check to make sure your kit includes all these bits, and check the contents of the envelopes against the parts inventory below. If anything is missing, contact the TAPR office.

Refer to the layout diagram for clarification of parts placement. All references to up, down, left, and right assume that you are looking at the PCB with the "TADD-1" text and copyright notice along the right-hand side of the board. All components are mounted on the top of the PC board.

If you plan to mount the TADD-1 using the four corner holes, now is a good time to use the PC board as a template for marking the mounting holes in your enclosure.

Check your soldering iron to be sure the tip is in good condition. The tip should be the small conical tip type and must be clean. If you can't remember when you last replaced the tip, now would be a good time to do so.

All parts should be mounted as nearly flush to the board surface as practical without stressing the lead.

Parts Inventory

OK?	Qty	Value	Part
	8	0.001uF	C5, C6, C7, C8, C18, C19, C33, C34
	7	0.01uF	C11, C13, C14, C25, C26, C37, C38
	18	0.1uF	C1, C2, C3, C4, C9, C10, C12, C15, C16, C17, C20, C21, C22, C29, C30, C35, C36, C41
	1	0.33uF	C40
	3	1uF	C42, C43, C44
	1	10uF	C39
	1	SA15A TVS	D1
	1	0.5A PICO FUSE	F1
	7	MAX477 AD8055	IC1, IC2, IC3, IC4, IC5, IC6, IC7
	1	LM7809	IC8
	7	BNC	J1, J3, J6, J7, J8, J9, J10
	7	Washer and Nut	--
	1	2-pin header and shorting block	JP3
	1	2-pin Molex header	JP5
	1	2-pin Molex connector	--
	2	Molex crimp pins	--
	1	1	R27
	8	51	R5, R7, R12, R18, R19, R21, R25, R26
	6	100	R2, R3, R16, R17, R23, R24
	1	220	R10
	1	270	R9
	2	560	R14, R15
	1	2.5k POT	R13
	1	2.7k	R11
	1	10k 1k	R4
	2	15k 47k	R1, R8
	1	100k	R6 DELETED
	7	T1-1-X65	T1, T2, T3, T4, T5, T6, T7

Resistor Installation

Ok	Procedure
	Install a 1 ohm resistor at R27.
	Solder and clip 2 leads.
	Install a 51 ohm resistor at R5, R7, R18, R19, R21, R25, R26
	Solder and clip 14 leads.
	<p>R12 provides a termination for the RF input. You have three configuration options:</p> <p>(a) Do not install the terminator (which will require using an external termination on the RF input cable);</p> <p>(b) Install the terminator and a jumper to make its use selectable. The jumper will cause a slight increase in input SWR (see the jumper installation instructions below); or</p> <p>(c) Install the terminator without a jumper. This will minimize input SWR. In this case, install a jumper wire across the two pins of JP3.</p> <p>Perhaps install a 51 ohm resistor at R12.</p>
	Perhaps solder and clip 2 leads.
	Install 100 ohm resistors at R2, R3, R16, R17, R23, R24. These resistors mount vertically. The body of the resistor should be next to pin 3 of the associated IC.
	Solder and clip 12 leads.
	Install a 220 ohm resistor at R10.
	Solder and clip 2 leads.
	Install a 270 ohm resistor at R9.
	Solder and clip 2 leads.
	Install a 560 ohm resistor at R14, R15.
	Solder and clip 4 leads.
	Install a 2.7k resistor at R11.
	Solder and clip 2 leads.
	Install a 10k 1k resistor at R4.
	Solder and clip 2 leads.
	Install a 15k 47k resistor at R1, R8.
	Solder and clip 4 leads.
	Install a 100k resistor at R6. DELETED
	Solder and clip 2 leads.

Diode Installation

Diodes are polarity sensitive devices. The cathode end of the diode is banded and corresponds to the banded silk-screen legend on the PC board. If you have never worked with these devices, take a look at the photograph showing the banded ends.

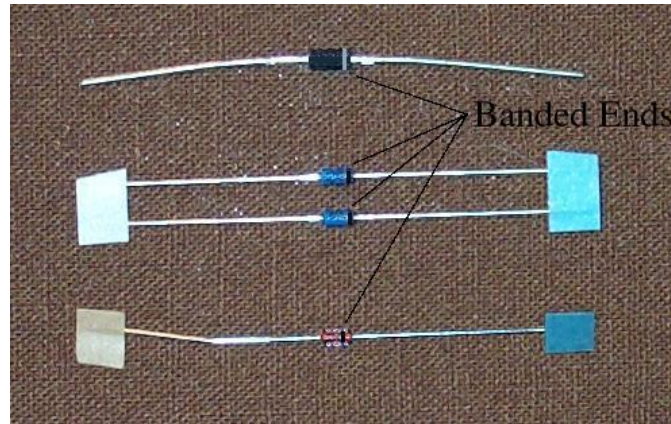

Ok	Procedure
	Install a SA15A TVS diode at D1.
	Solder and clip 2 leads.

Fuse Installation

Ok	Procedure
	Install a 0.5 amp PicoFuse at F1.
	Solder and clip 2 leads.

Capacitor Installation

Ok	Procedure
	Install a 0.001 uF (102) capacitor at C5, C6, C7, C8, C18, C19, C33, C34
	Solder and clip 16 leads.
	Install a 0.01 uF (103) capacitor at C11, C13, C14, C25, C26, C37, C38
	Solder and clip 14 leads.
	Install a 0.1 uF (102) capacitor at C1, C2, C3, C4, C9, C10, C12, C15, C16, C17, C20, C21, C22, C29, C30, C35, C36, C41
	Solder and clip 36 leads.
	Install a 0.33 uF (334) at C40. This is a polarized capacitor. The positive lead should be toward the voltage regulator IC, and the negative lead toward the front of the board.
	Solder and clip 2 leads.
	Install a 1 uF (101) at C42, C43, C44
	Solder and clip 6 leads.

Electrolytic capacitors are polarized. The positive lead goes in the hole on the board marked with a "+".

NOTE: The orientation of the positive (+) leads are not all the same. Be careful! The negative or the positive lead may be marked.

Ok	Procedure
	Install a 10 uF electrolytic capacitor at C39. the positive lead should be toward the front of the board.
	Double-check polarity and then solder/clip 2 leads.

Trimmer Installation

Ok	Procedure
	Install a 2.5k trimmer at R13.
	Solder and clip 3 leads.

Transformer Installation

The small dot, or the notch in the transformer body, is on the end with pins 1 and 6. Make sure the notch or dot on the component matches the notch on the silkscreen!

Ok	Procedure
	Install a T1-1X65 transformer at T1, T2, T3, T4, T5, T6, T7.
	Solder and clip 42 leads.

Header and Connector Installation

Headers

The male headers will be installed next. The plastic body of the part should rest flush with the top surface of the PC board. Note that the short end of the pins go into the PC board, the long ends stick up.

WARNING! Do not hold these parts with your fingers while soldering. The pins get very hot. Place one of the shunts on the header to insulate your finger from the pins, hold the header in place and tack solder one pin. Check for proper alignment. If alignment is off, you can reheat the pin to adjust. Once alignment is correct, solder the remaining pins and then reflow (reheat) the first pin soldered.

Ok	Procedure
	Install the 1x2 (2-pin) DIP header at JP3.
	Install shunt, and solder all pins.
	Install the 2 pin polarized Molex header at JP5. Position the header so that the locking pin faces the back of the board.
	Solder 2 pins.
	Remove any shunts used during the soldering operation.

Jumpers

	If you ARE NOT installing the bandpass filter option, install a wire jumper at J2. You can use leads clipped from resistors or capacitors for this. If you are installing the BPF, DO NOT install J2.
	Solder and clip excess wire from 2 pins.

Connectors

	Install BNC connectors at at J1, J2, J3, J4, J5, J6, J7.
	Solder 28 pins.

Initial Test -- 1

Preliminaries

Errors take two forms, the kind that damage components and the kind that don't. Neither is desirable, but the type that damages components will require you to find a replacement part. Before connecting the board for the first time, check the following:

Ok	Procedure
	Polarity of the electrolytic capacitor. The negative lead is usually identified with a white stripe and a big minus sign on it. The positive lead is identified on the PC board.
	Polarity of the four tantalum capacitors. The positive lead is usually identified with a red line and plus signs.
	Polarity of diode D1. The band on the diode should align with the extra stripe on the PC board silkscreen.
	The orientation of the integrated circuits with pin 1 correctly oriented to the dot, notch or bevel outline on the PC board.

Be Alert! Observe anything unusual such as components heating up, smoke or smell. If anything unusual appears, immediately turn off the power. Find and correct all problems before continuing.

Ok	Procedure
	Place the ground lead of your meter on the anode (opposite the banded end) of D1. This is ground reference for all measurements.
	With the meter set to read ohms, check pins 1 and 3 of IC8. These may show a low resistance initially because of charging effects, but after a few seconds the resistance at pin 1 should be greater than 10kohms, and at pin 3 greater than 500 ohms. If either shows a very low resistance, check your work for short circuits.

Integrated Circuit Installation -- 1

Integrated circuits are polarity sensitive devices. The small notch in the body is on the end with pins 1 and 8. Make sure the notch on the component matches the one on the silkscreen!

Ok	Procedure
	Install a 7809 voltage regulator IC at IC8. The regulator can be mounted either flat on the board, or standing vertically, depending on the space available in your configuration. The heat sink tab should face the bottom or the back of the board.
	Solder and clip 3 leads.

Initial Test -- 2

Ok	Procedure
	Place the ground lead of your voltmeter on the anode (opposite the banded end) of D1. This is ground reference for all measurements.
	Apply 13.8V power to JP5.
	Measure the voltage on the 9V bus by connecting the other lead of the meter to the cathode of D1. This should be 9 volts, $\pm 0.25V$. If not, fix the problem before proceeding.
	If you have an ammeter, measure the current draw on the 12 volt input. It should be less than 25ma. If it is significantly more, there is likely a short circuit.
	Remove power from the circuit.

Integrated Circuit Installation -- 2

Integrated circuits are polarity sensitive devices. The small notch in the body is on the end with pins 1 and 8. Make sure the notch on the component matches the one on the silkscreen!

Do not mount the MAX477 ICs in sockets! Using sockets could lead to circuit instabilities.

Ok	Procedure
	Install a MAX477 AD8055 IC at IC2, IC3, IC4, IC5, IC6, IC7.
	Solder and clip 42 leads.

Initial Test -- 3

Ok	Procedure
	If you have an ammeter, connect it in series with the 12 volt power lead and make this test.
	Apply 13.8V power to JP5.
	Measure the current draw. It should be about 60ma. If it is over 150ma, there is likely a short in the DC bus. If it is more than 70ma and less than 150ma, there is likely a spurious oscillation. Check to make sure you've installed the 100 ohm resistors at the inputs to IC2-IC7 with the body of the resistor closest to the IC.
	Remove power from the circuit.

Optional Bandpass Filter Installation

Mounting points are provided on the circuit board for a bandpass filter that can be used to improve the waveform of the input signal. This may be useful, for example, if your frequency standard has a square wave output and you would like to distribute sine wave signals.

~~The component values shown here will create a filter centered at 10MHz with an approximate 1MHz bandwidth.~~

~~For a 5MHz center frequency, with a 0.5MHz bandwidth, L1 and L2 should each be 29uH. C23 and C24 should each be 39pF; C27 and C28 are not needed. Each pair of C23/C27 and C24/C28 should total 38pF (a single 39pF cap is close enough). C31 should be 390pF and C32 is not needed.~~

Somewhere along the way the filter component values and toroid winding instructions were messed up. I've recalculated a reasonable set of values for 10 MHz using the "Elsie" filter design program – 13.7uH for the series inductors, 22pF for the series caps, and 120pF for the shunt cap. The inductors will be 53 turns on a T-50-2 core. Those are shown in the instructions below. I have not built this filter (see note above), so can't guarantee the values. NOTE THAT THE SCHEMATIC HAS **NOT** BEEN UPDATED WITH THESE VALUES!

Ok	Procedure
	Install a 51 ohm resistor at R21.
	Solder and clip 2 leads.
	Install a 15k ohm resistor at R20, R22
	Solder and clip 4 leads.
	Install 22pf capacitors at C27 and C28. C23 and C24 allow combining standard value caps to come close to the calculated value and should not be needed.
	Solder and clip 4 leads.
	Install 120pF capacitor at C31. C32 can be used to combine standard value caps to come close to the calculated value and should not be needed..
	Solder and clip 2 leads.
	Install 0.1uf capacitor at C22.
	Solder and clip 2 leads.
	Wind the inductors. For 10MHz, the nominal value is 13.7uH. To obtain this value, wind 53 turns of 24 or 26 gage AWG wire on an Amidon T-50-2 core..
	Install toroid inductors at L1 and L2.
	Solder and clip 4 leads.
	Install wire jumpers at J1 and J3. If you are installing the BPF option DO NOT install J2!
	Solder and clip 4 leads.

Board Check

This completes assembly of the TADD-1. At this point, components, their location, and proper orientation should be double-checked. Soldering must be carefully inspected, preferably with a lit magnifier. If there are any suspicious solder connections, reflow the solder and check the result. Do this until you are satisfied that the board is OK.

Ok	Procedure
	Board checked and OK.

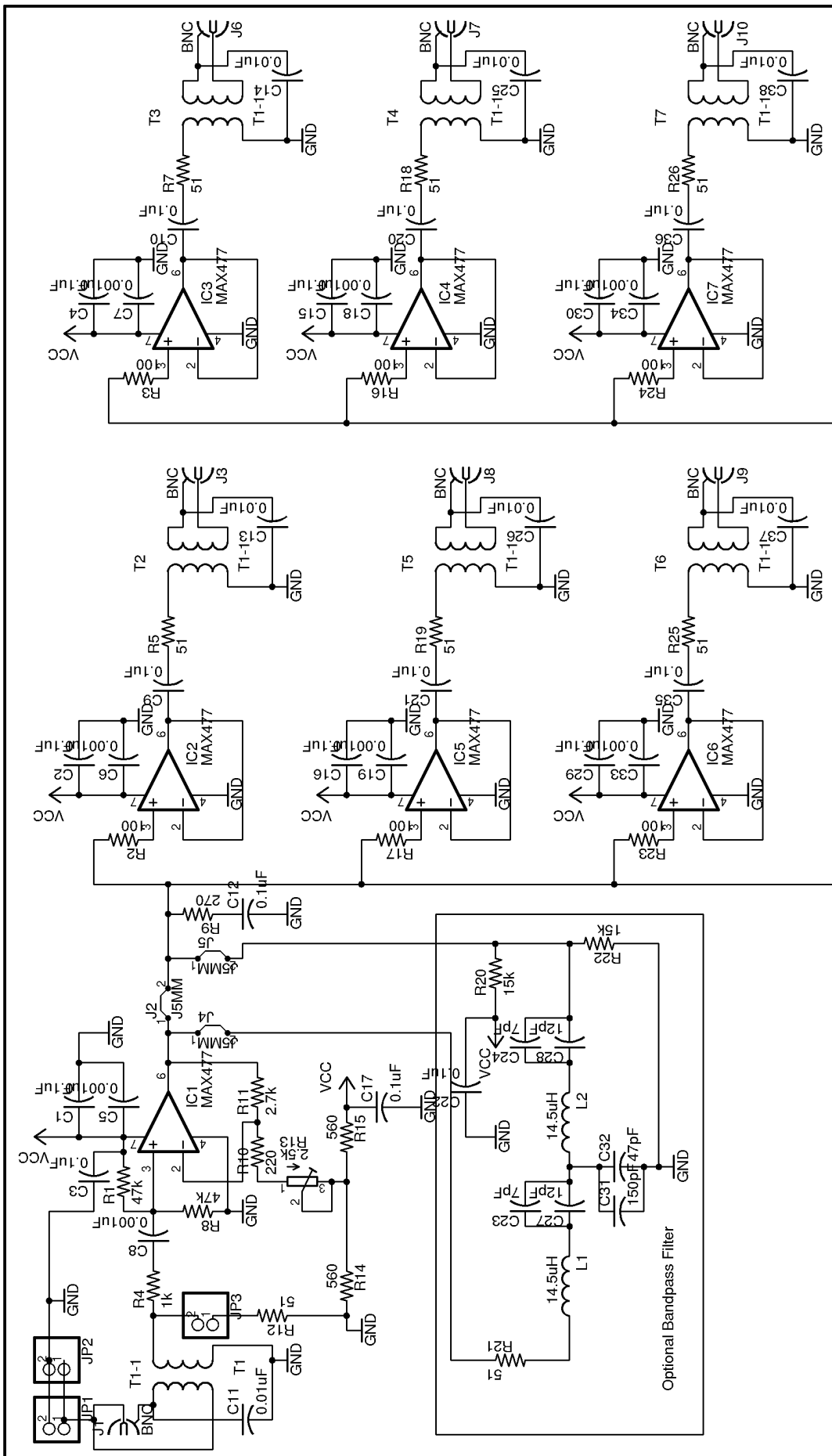

TITLE: tadd-1d	REV:
Document Number:	
Date: 9/09/2006 12:23:05	Sheet: 1/1

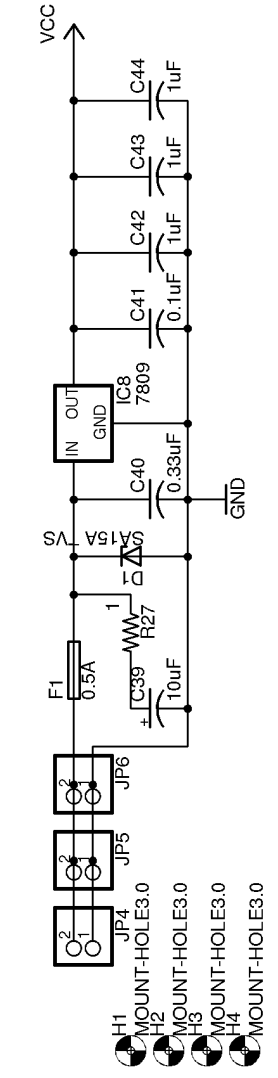

- H1 MOUNT-HOLE3.0
- H2 MOUNT-HOLE3.0
- H3 MOUNT-HOLE3.0
- H4 MOUNT-HOLE3.0
- JP4
- JP5
- JP6

