

TAPR TNS-BUF Isolation Amplifier

Usage Manual – 04 October 2016

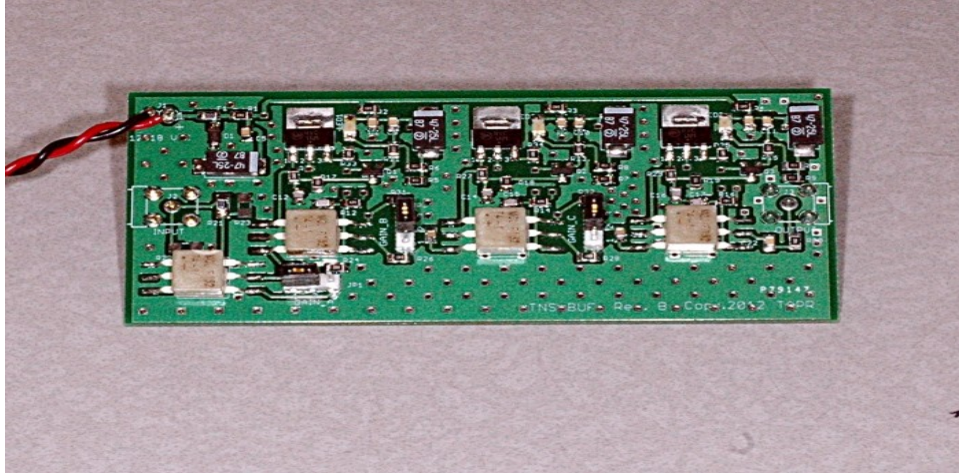

The [TAPR](#) TNS-BUF is a very low noise, high isolation, buffer amplifier for use in time and frequency measurement applications. It's designed for use at 5 or 10 MHz, but is usable with some loss of gain from 1 MHz to at least 50 MHz. The TNS-BUF circuit was designed by Bruce Griffiths, and John Miles, KE5FX, provided valuable input on both schematic and layout. John Ackermann, N8UR did the board layout and testing, and acted as project manager.

This page documents performance of the Rev. B prototype; production units will be based on the Rev. C board, which is electrically identical.

The TNS-BUF is built on a 1.75 x 3.75 inch board using 0805 size surface mount components. Two SMA vertical connectors mount on the rear side. This allows the board to be mounted in the top of a die-cast box (I used a Hammond model 1590N1).

Operation

The TNS-BUF is designed for operation at 18VDC. Tests indicate that performance is not degraded with supply voltages down to 12V, though the maximum output level will be reduced. For sensitive measurements, the power supply should be well regulated and bypass capacitors should be installed near the board.

For best results the board should be mounted in a shielded enclosure, with DC power provided using a feed-through capacitor. The TNS-BUF component side should also be protected from light – the three LEDs used in the bias circuits are photosensitive and can introduce spurs if exposed to bright incandescent or fluorescent lights.

The TNS-BUF is optimized for use at 5 and 10 MHz, but will operate from about 1 MHz through at least 50 MHz. The RF input impedance is approximately 50 ohms. Plots later in this document show the gain and input match versus frequency.

Gain is adjustable from about -10 dB to +10 dB via three jumpers that select the gain for each amplifier stage. Maximum output when operated from 18V is at least +18 dBm. At lower voltages, the output level will decrease. This table shows the possible jumper settings and their results:

GAIN_A	GAIN_B	GAIN_C	Gain
1-2	1-2	1-2	-11
2-3	1-2	1-2	-5
2-3	2-3	1-2	+1
2-3	2-3	2-3	+7
1-2	2-3	2-3	+1

Two important notes:

1. For best phase noise, use the jumper selection that puts the higher gain (e.g., the 2-3 setting) in the earlier amplifier stages. For example using the 2-3/2-3/1-2 setting rather than the 1-2/2-3/2-3 setting will improve phase noise by as much as 10 dB.
2. For best input match (best SWR) and frequency response, it's best to use the low gain setting on the first amplifier (set GAIN_A to 1-2), particularly at frequencies above 15 MHz. Of course, this contradicts the previous paragraph, so you'll have to pick your poison.

Phase Noise

Here is a plot of the TNS-BUF additive phase noise using a 5 MHz ULN source. The "bullet" trace shows the system noise floor with the TNS-BUF replaced by an SMA bullet.

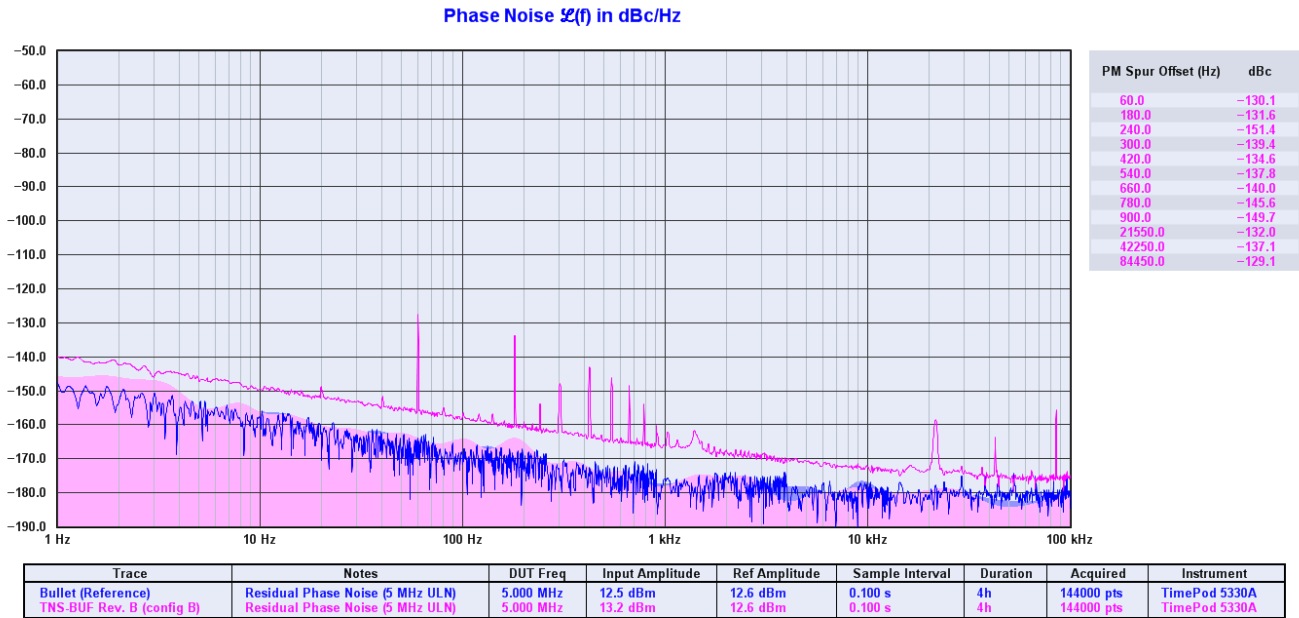

In this plot, the TNS-BUF jumpers were set to 2-3, 2-3, 1-2 to yield about 1 dB gain (see above for a complete table of gain versus jumper settings). It's **very** important to use this rather than the alternative 1-2, 2-3, 2-3 setting; that setting causes a phase noise increase of more than 10dB.

Here is the Allan Deviation derived from the same data run:

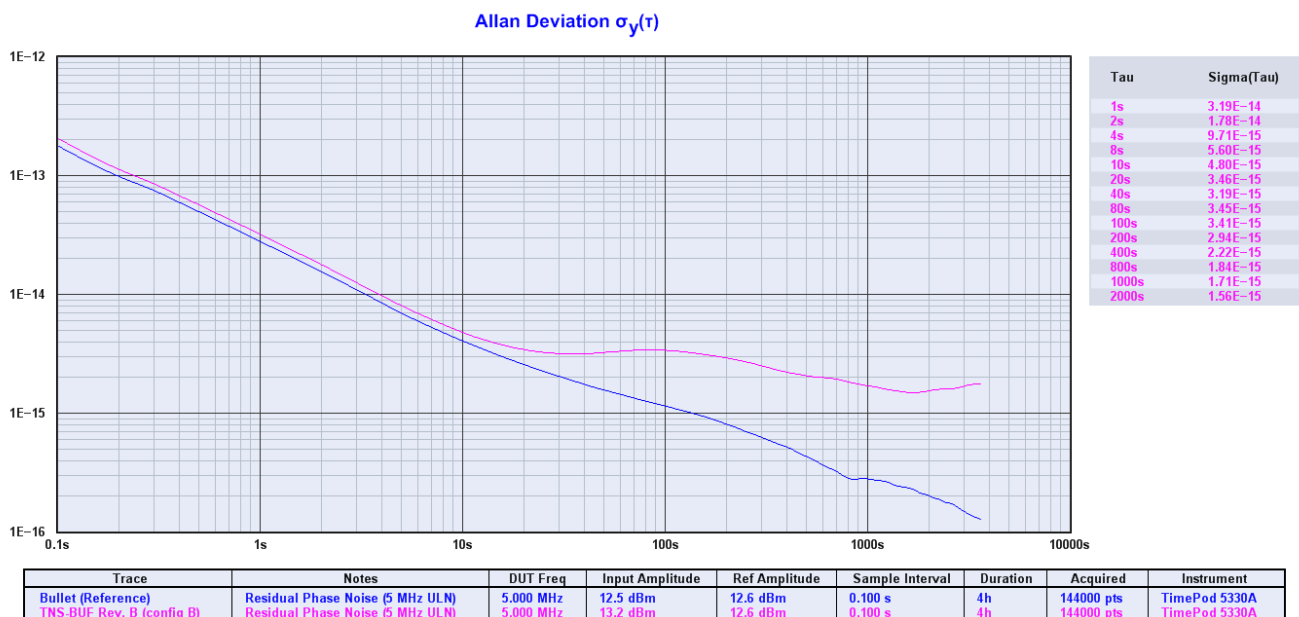

And this shows the phase residuals over that 4 hour period:

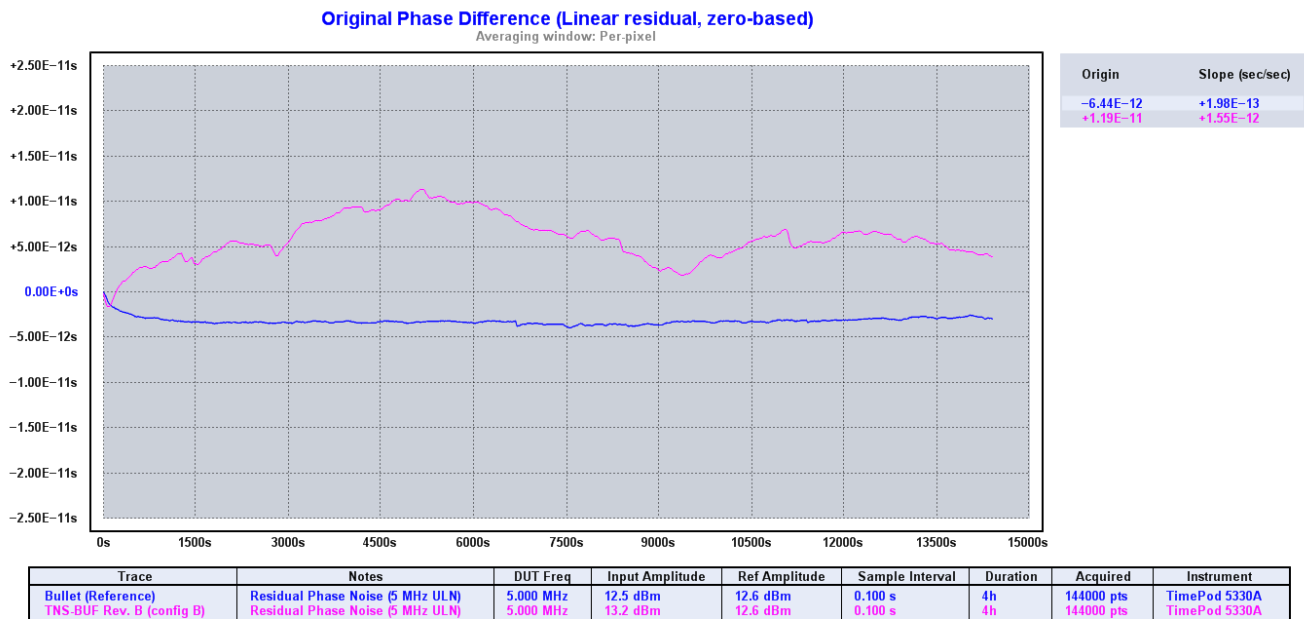

Gain, Input Match, and Bandwidth

The following plots show the gain and return loss with all jumpers set for maximum (yellow and cyan) and minimum (green and red) gain.

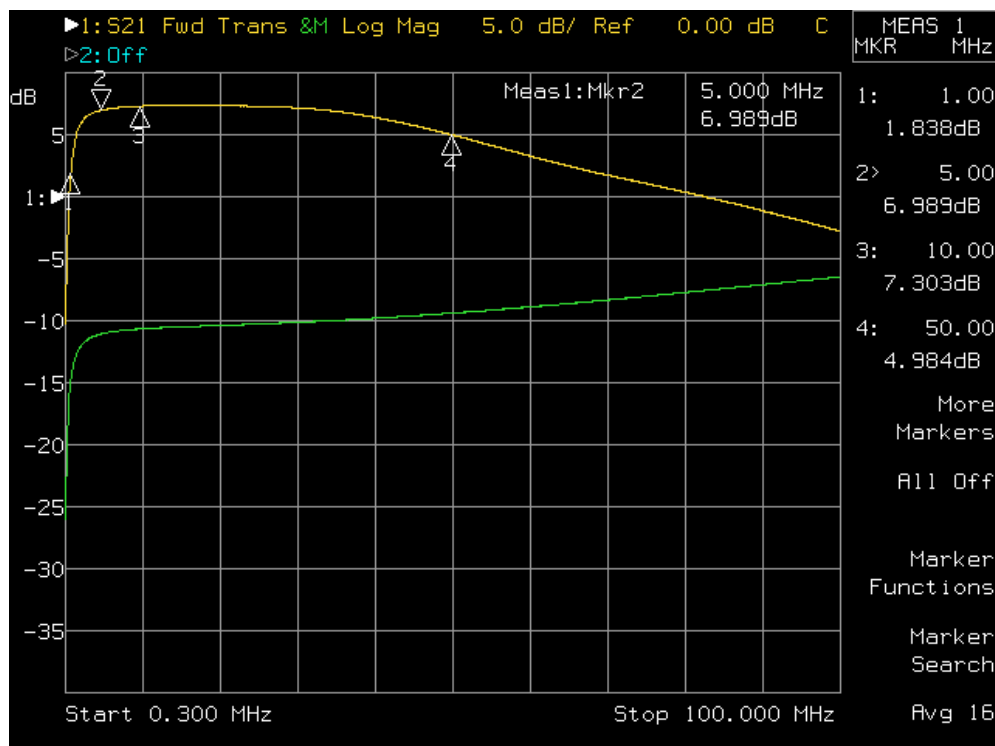

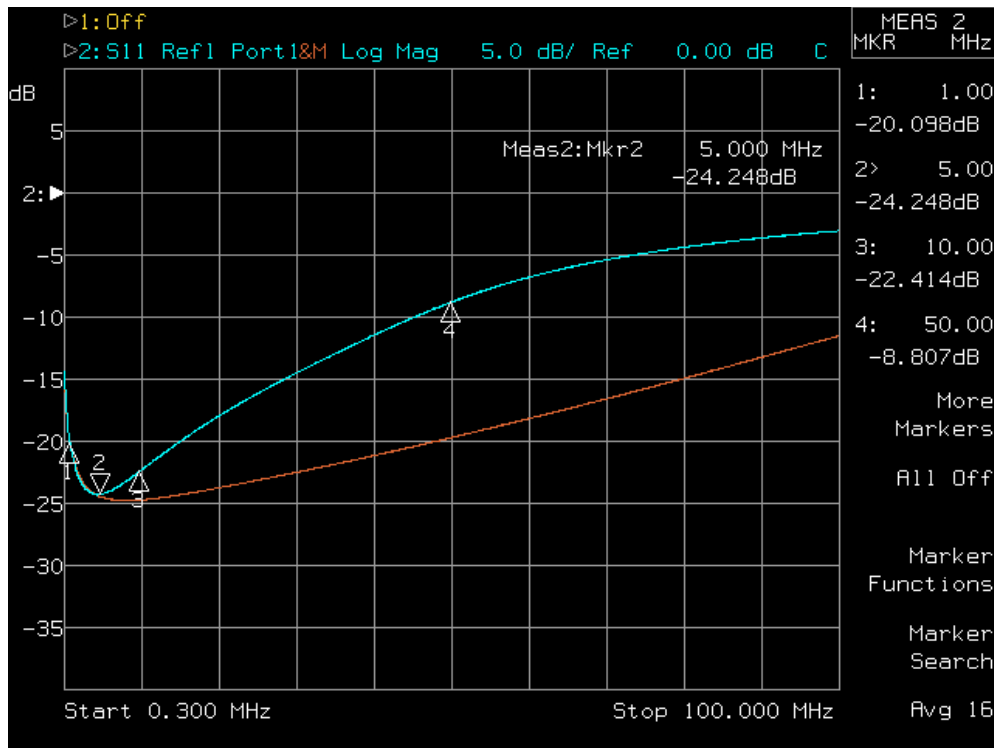

GAIN_A has the most impact on frequency response and return loss. From the table above, it looks like gain settings 2-3/2-3/1-2 and 1-2/2-3/2-3 yield about the same gain at 5 and 10 MHz. But at 80 MHz the first setting gives -1.2 dB gain and a return loss of 4.2dB, while the second -2.7 dB but has a much better return loss of 13.9 dB. At 10 MHz, the return loss is marginally better with GAIN_A set to the low position. Relative gain and return loss at 1 MHz are not noticeably affected by the GAIN_A setting; gain is down about 4 dB from that at 5 MHz and the return loss is about 20 dB. The limiting factor at the low end of the range is the performance of the four Minicircuits transformers, which are spec'd for 1 MHz and above.

Reverse Isolation

A key requirement for many applications is high reverse isolation -- that is, how much a signal going backwards through the buffer is attenuated. High attenuation is required to avoid injection locking and other problems in low noise measurements.

The theoretical reverse isolation of the TNS-BUF is well over 100dB, which is a tough thing to measure. With all the stops pulled out, my old 8753C VNA can measure down to about -110dB. The TNS-BUF was at the floor of that measurement. An alternative measurement using a signal generator and spectrum analyzer shows an isolation at the minimum gain setting of **111.8 dB**, and at the maximum gain setting of **103.7 dB**.

Given the high dynamic range required for this measurement, I don't want to issue a specific isolation specification, but it's safe to say that the TNS-BUF has at least 100-110 dB of isolation.

TNS-BUF Schematic

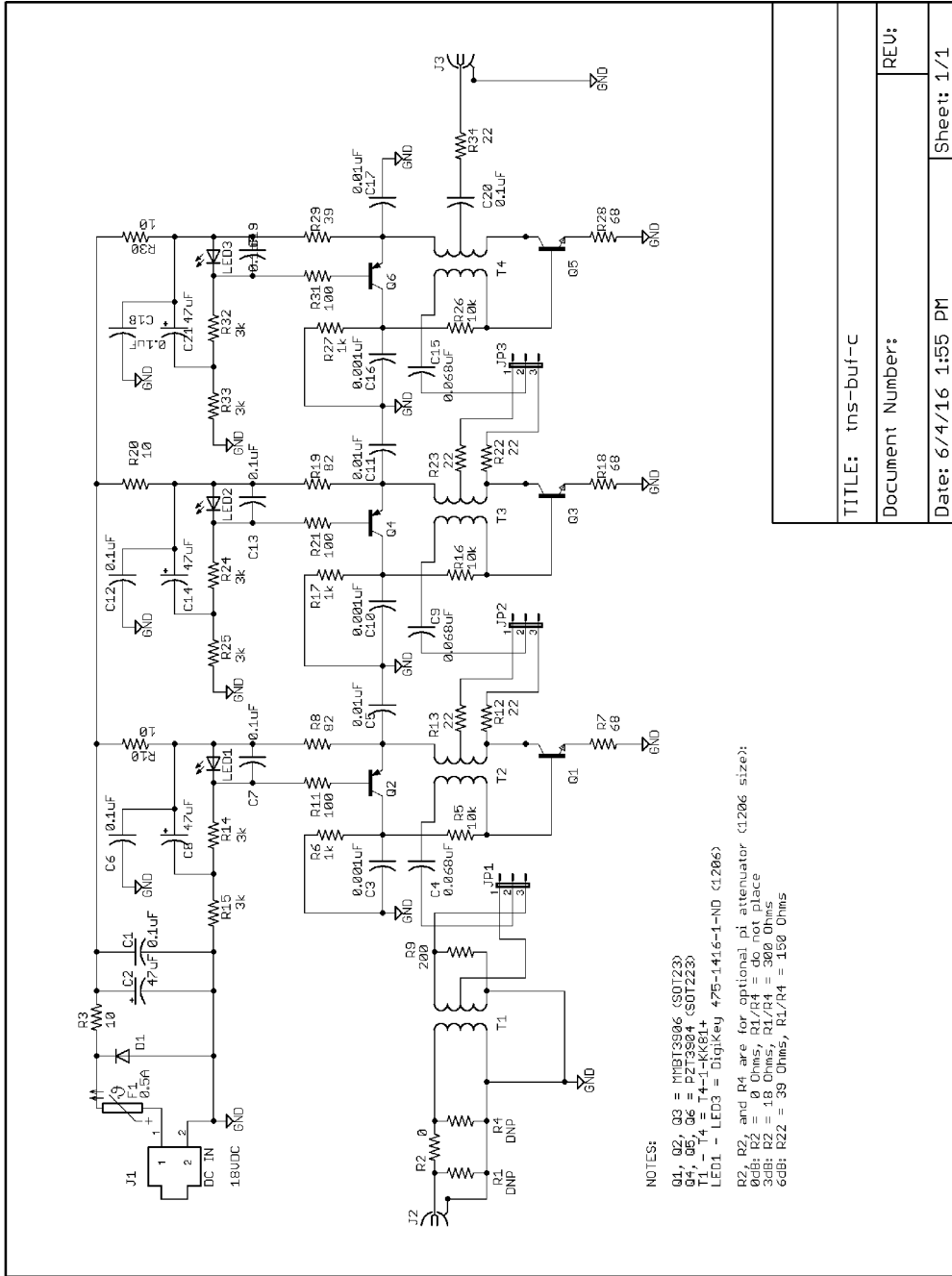

NOTES:
 Q1, Q2, Q3 = MMBT3906 (SOT23)
 Q4, Q5, Q6 = P2T3804 (SOT223)
 T1 - T4 = T4-1-KK61+
 LED1 - LED3 = DigKey 475-1416-1-ND (1206)
 D2, D2, and D4 are for optional pi attenuator (1206 size):
 0dB: R2 = 0 Ohms, R1/R4 = do not place
 3dB: R2 = 18 Ohms, R1/R4 = 300 Ohms
 6dB: R2 = 39 Ohms, R1/R4 = 150 Ohms

TITLE: tns-buf-c
Document Number:
Date: 6/4/16 1:55 PM
Sheet: 1/1

REV:
